

SCHMID-M

SCF0505XT-1WR2

1W, FIXED INPUT, ISOLATED & UNREGULATED SINGLE OUTPUT



Continuous Short
Circuit Protection

FEATURES

- Miniature SMD package
- 3500VDC isolation
- Operating temperature range: -50°C~+125°C
- Short circuit protection(automatic recovery)
- Internal SMD construction
- Industry standard pinout
- Components meet AEC-Q100 standards
- The production process meet TS16949 system requirements

APPLICATIONS

The SCF0505XT-1WR2 is designed for application where isolated output is required from a distributed power system. It can be used in automobile motor control and drive system. Such as motor vehicle communication system controller, engine control system, the ignition system, the motor voltage monitoring, the electronic accelerator pedal, automobile tire pressure detection system, doors and tail lights controller, air conditioning control and battery management system (BMS), etc.

PART NUMBER SYSTEM

SCF0505XT-1WR2

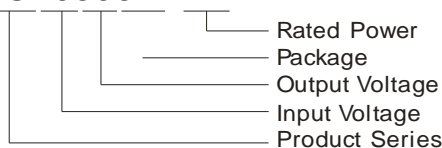

SELECTION GUIDE

Model	Input Voltage(VDC) Nominal (Range)	Output Voltage (VDC)	Output Current (mA)		Input Current (mA,Typ.)		Reflected Ripple Current (mA,Typ.)	Max. Capacitive Load(μF)	Efficiency (%, Typ.)
			Max.	Min.	@Max. Load	@No Load			
SCF0505XT-1WR2	5 (4.5-5.5)	5	200	20	267	20	15	220	75

INPUT SPECIFICATIONS

Item	Test Conditions	Min.	Typ.	Max.	Unit
Input Surge Voltage (1 Sec. Max.)	5VDC Input	-0.7	--	9	VDC
Input Filter		Capacitor			

OUTPUT SPECIFICATIONS

Item	Test Conditions	Min.	Typ.	Max.	Unit
Output Voltage Accuracy		See tolerance envelope curve			
Line Regulation	For Vin change of ±1%	--	--	±1.2	%
Load Regulation	10% to 100% load	--	12	--	%
Temperature coefficient	100% load	--	--	±0.03	%/°C
Ripple & Noise*	20MHz Bandwidth	--	60	--	mVp-p
Short Circuit Protection		Continuous, automatic recovery			

Note:* Ripple and noise tested with "parallel cable" method. See detailed operation instructions at *DC-DC Application Notes*.

COMMON SPECIFICATIONS

Item	Test Conditions	Min.	Typ.	Max.	Unit
Isolation Voltage	Input-Output, tested for 1 minute and leakage current less than 1 mA	3500	--	--	VDC
Isolation Resistance	Input-Output, test at 500VDC	1000	--	--	MΩ
Isolation Capacitance	Input-Output, 100KHz/0.1V	--	20	--	pF
Switching Frequency	Full load, nominal input	--	100	300	KHz
MTBF	MIL-HDBK-217F@25°C	3500	--	--	K hours
Case Material		Epoxy Resin (UL94-V0)			
Weight		--	1.5	--	g

ENVIRONMENTAL SPECIFICATIONS

Item	Test Conditions	Min.	Typ.	Max.	Unit
Storage Humidity	Non condensing	--	--	95	%
Operating Temperature	Power derating ($\geq 105^{\circ}\text{C}$, see Figure 2)	-50	--	125	$^{\circ}\text{C}$
Storage Temperature		-55	--	135	
Temperature rise	$T_a=25^{\circ}\text{C}$, 100% Load	--	25	--	
Lead Temperature	1.5mm from case for 10 seconds	--	--	300	
Cooling		Free air convection			

EMC SPECIFICATIONS

EMI	CE	CISPR25/EN55025 CLASS 1 (External Circuit Refer to Figure1)
ESD	ESD	ISO10605 Contact $\pm 6\text{KV}$ perf. Criteria B

EMC RECOMMENDED CIRCUIT

EMI Typical Recommended Circuit (CLASS 1):

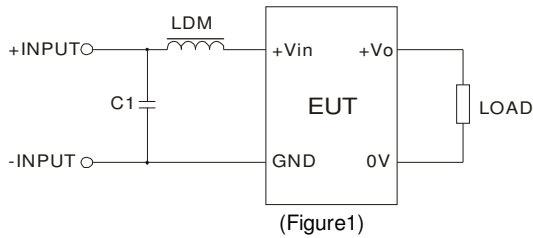

Recommended typical circuit parameters:

Vin(V)		5
EMI	C1	10 μF
	LDM	12 μH

EMC TEST WAVEFORM (CLASS B APPLY CIRCUIT)

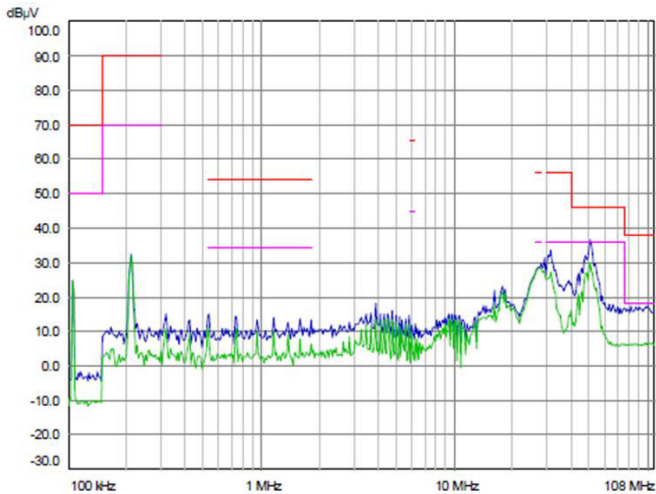

SCF0505XT-1WR2 CE(Positive line)

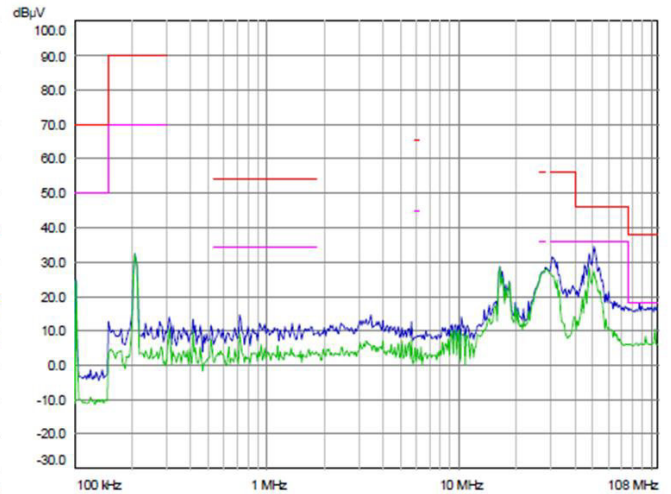

SCF0505XT-1WR2 CE(Negative line)

PRODUCT TYPICAL CURVE

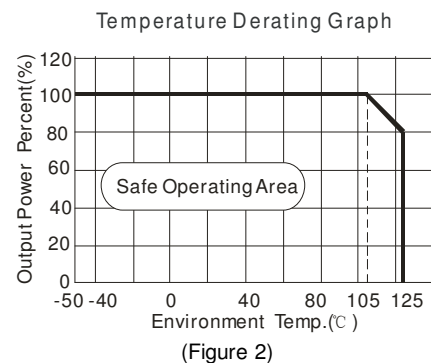
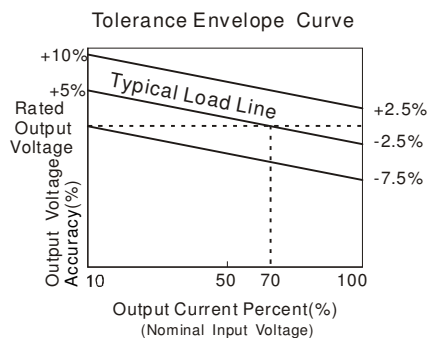

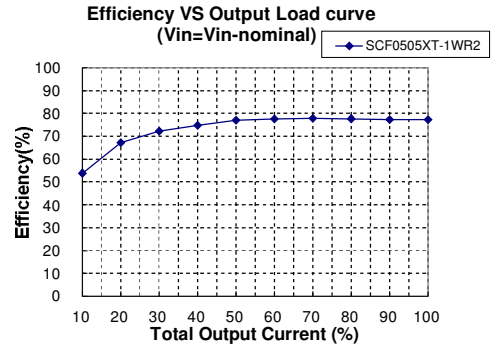
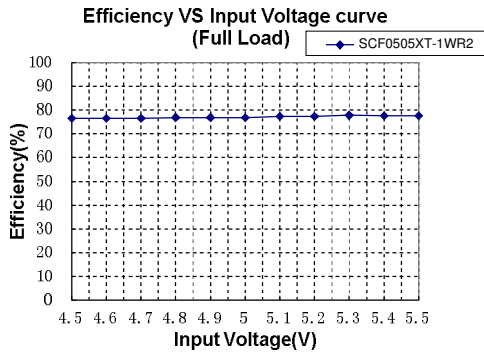

Recommended reflow soldering profile refer to IPC/JEDEC J-STD-020D standard, our products recommended reflow soldering profile as follow:

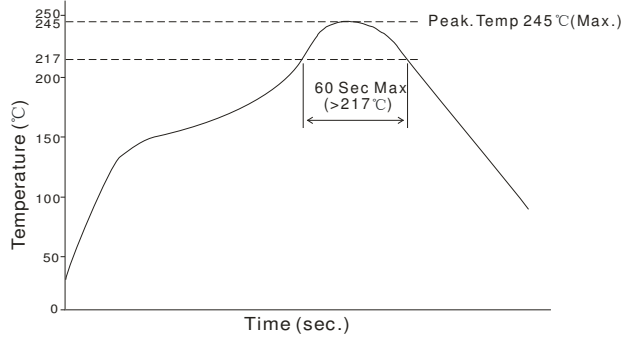

Note: The curve only applies to the hot air reflow soldering

DIMENSIONS, RECOMMENDED FOOTPRINT & PACKAGING

MECHANICAL DIMENSIONS

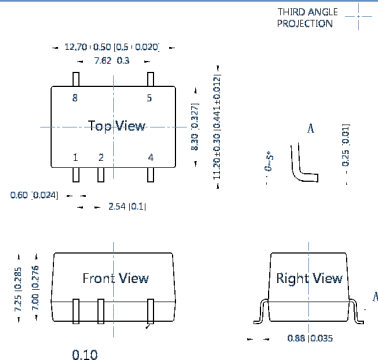

Note:
Unit: mm[inch]
Pin section tolerances: ±0.10[±0.004]
General tolerances: ±0.25[±0.010]

RECOMMENDED FOOTPRINT DETAILS

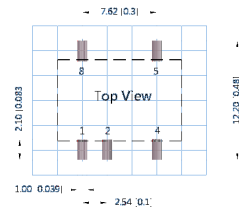

Note: Grid 2.54*2.54mm

PIN CONNECTION	
Pin	Function
1	GND
2	Vin
4	0V
5	+Vo
8	NC

NC: No Connection

TUBE PACKAGING DIMENSIONS

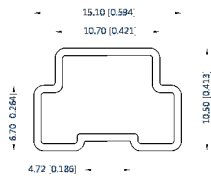

Note:
Unit: mm[inch]
General tolerances: ±0.50[±0.020]
L=530[20.866] Quantity: 40pcs
L=220[8.661] Quantity: 15pcs
Inner carton(S): L*W*H=255*170*80
Outer carton(S): L*W*H=375*280*270
Inner carton(L): L*W*H=580*200*100
Outer carton(L): L*W*H=600*215*220, 2 inner cartons(L)
Outer carton(L): L*W*H=600*215*325, 3 inner cartons(L)

REEL PACKAGING DIMENSIONS

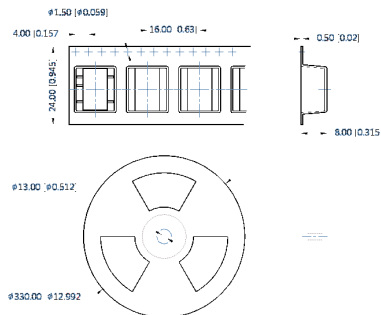

Note:
Unit: mm[inch]
General tolerances: ±0.50[±0.020]
Per reel of packing quantity: 5000pcs
Inner carton: L*W*H=365*350*105
Quantity: 2000pcs
Outer carton: L*W*H=390*360*245
Quantity: 4000pcs

TEST CONFIGURATIONS

Input Reflected-Ripple Current Test Setup

Input reflected-ripple current is measured with an inductor L_{in} and Capacitor C_{in} to simulate the source impedance .

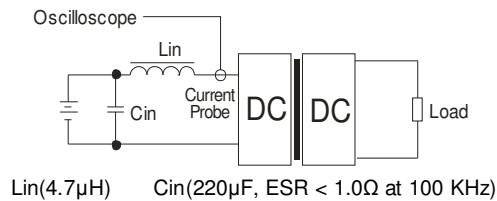

DESIGN CONSIDERATIONS

1) Requirement for output load

To ensure this module can operate efficiently and reliably, the minimum output load could not be less than 10% of the full load. If the actual output power is very small, please connect a resistor to the output in parallel to increase the load.

2) Overload Protection

Under normal operating conditions, the output circuit of these products have not overload protection. The simplest method is to add a breaker circuit in the circuit.

3) Recommended circuit

If you want to further decrease the input/output ripple, an capacitor filtering network may be connected to the input and output ends of the DC/DC converter, refer to Figure 3.

It should also be noted that the capacitance of the capacitor must be proper. If the capacitance is too large, a startup problem might arise. For ensuring every channel of output can provide a safe and reliable operation , the recommended capacitance of the capacitor refer to Table 1.

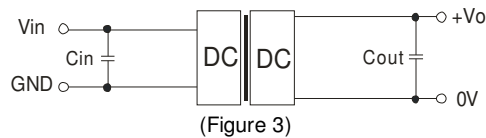

EXTERNAL CAPACITOR TABLE (Table 1)

Vin (VDC)	Cin (μF)	Vo (VDC)	Cout (μF)
5	4.7	5	10

It's not recommended to connect any external capacitor in the application field with less than 0.5 watt output.

4) Output Voltage Regulation and Over-voltage Protection Circuit

The simplest device for output voltage regulation, over-voltage and over-current protection is a linear regulator with overheat protection which is connected to the input or output in series (Figure 4) and an capacitor filtering network.the recommended capacitance of the capacitor refer to Table 1, linear regulator based on the actual voltage and current to make a reasonable selection.

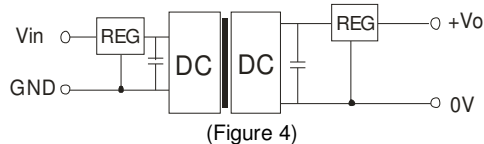

5) It is not recommended to increase the output power capability by connecting two or more converters in parallel. The product is not hot-swappable

Note:

1. Operation under minimum load will not damage the converter; However, they may not meet all specifications.
2. Max. Capacitive Load is tested at nominal input voltage and full load.
3. Unless otherwise noted, All specifications are measured at $T_a=25^\circ\text{C}$, humidity<75%, nominal input voltage and rated output load.
4. In this datasheet, all test methods are based on our corporate standards.
5. All characteristics are for listed models, and non-standard models may perform differently. Please contact our technical support for more detail.
6. Please contact our technical support for any specific requirement.
7. Specifications of this product are subject to changes without prior notice.