

SE-2W Series

2W Unregulated Single output

Features

- 4 Pin SIL Package
- 1000 VDC Isolation
- Up to 3000 VDC Isolation
- Low Ripple and Noise
- Efficiency up to 88%
- -40 ~ 85°C Operation Temperature Range
- Non-Conductive Black Plastic Case
- EMI Complies With EN55032 Class B

SCHMID-M

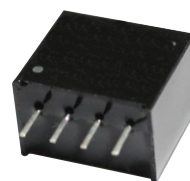

CE

The SE series is a family of cost effective 2W single output DC-DC converters. These converters achieve low cost and ultra-miniature SIP 4 pin size. Devices are encapsulated using flame retardant resin. The models operate from input voltage of 5, 12, 15, 24, 48 Vdc with output voltage of 3.3, 5, 7.2, 9, 12, 15, 24 Vdc. High performance features include 1000Vdc~3000Vdc input/output isolation, high efficiency operation and output voltage accuracy of $\pm 3\%$ maximum. Standard features include an input range of $\pm 10\%$ tolerance and low output noise and ripple.

All specifications typical at $T_a=25^\circ\text{C}$, nominal input voltage and full load unless otherwise specified

OUTPUT SPECIFICATIONS	
Output Voltage accuracy	$\pm 3\%$, max.
Line regulation	$\pm 1.2\%$ / Per 1% V_{in} Change
Load regulation	(From 20% to 100% Load) $\pm 10\%$, max. (Output 3.3V Model) $\pm 20\%$, max.
Ripple & noise (20 MHz bandwidth)(1)	150mVpk-pk, max.
Temperature coefficient	$\pm 0.02\%/^\circ\text{C}$
Capacitor load(2)	See table, max.

INPUT SPECIFICATIONS	
Input Voltage Range	$\pm 10\%$
Input Current	See table, typ.
Input Current(No-Load)	See table, max.
Input Filter	Capacitors
Input Reflected Ripple Current(3)	20mApk-pk, typ.

PHYSICAL SPECIFICATIONS	
Case Material	Non-conductive Black Plastic(UL94V-0 rated)
Pin Material	0.5mm Alloy42 Solder-coated
Potting Material	Epoxy (UL94V-0 rated)
Weight	1.9g
Dimensions	0.46"x0.29"x0.40"

ENVIRONMENT SPECIFICATIONS	
Operating Temperature	-40°C~85°C
Maximum Case Temperature	100°C
Storage Temperature	-40°C~125°C
Cooling	Nature Convection

ABSOLUTE MAXIMUM RATINGS(4)	
These are stress ratings. Exposure of devices to any of these conditions may adversely affect long-term reliability.	
Input Surge Voltage(100mS)	
5 Models	7 Vdc, max.
12 Models	15 Vdc, max.
15 Models	18 Vdc, max.
24 Models	28 Vdc, max.
48 Models	54 Vdc, max.
Soldering Temperature (1.5mm from case 10sec max.)	260°C, max.

GENERAL SPECIFICATIONS	
Efficiency	See table
I/O Isolation Voltage(60sec)	
Input/Output	1000~3000Vdc
I/O Isolation Capacitance	60 pF Typ.
I/O Isolation Resistance	1000M Ohm
Switching Frequency	Variable 70kHz
Humidity	95% rel H
Reliability Calculated MTBF(MIL-HDBK-217 F)	>1.121Mhrs
Safety Standard : (designed to meet)	IEC 60950-1

EMC SPECIFICATIONS		
Radiated Emissions	EN55032	CLASS B
Conducted Emissions (6)	EN55032	CLASS B
ESD	IEC 61000-4-2	Perf. Criteria A
RS	IEC 61000-4-3	Perf. Criteria A
EFT (7)	IEC 61000-4-4	Perf. Criteria A
Surge (7)	IEC 61000-4-5	Perf. Criteria A
CS	IEC 61000-4-6	Perf. Criteria A
PFMF	IEC 61000-4-8	Perf. Criteria A

SE-2W Unregulated Single output

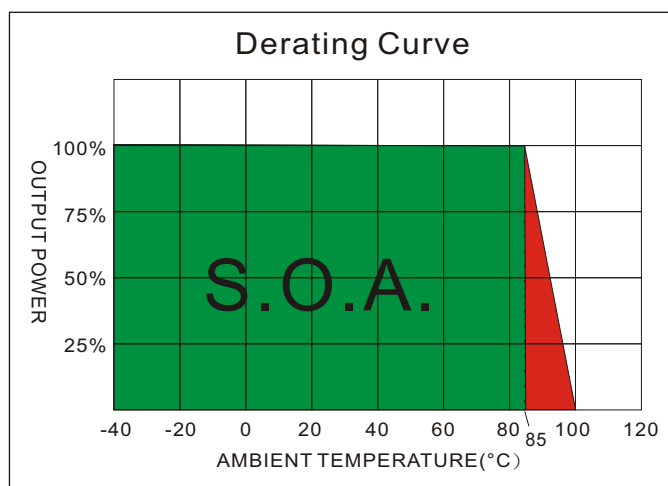
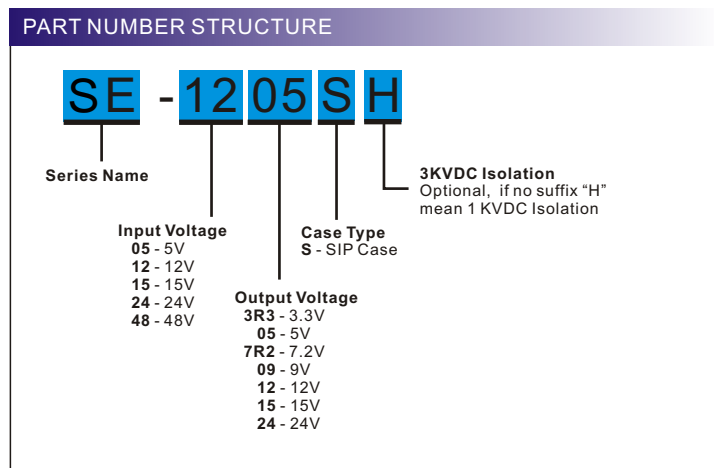

MODEL SELECTION GUIDE

MODEL NUMBER	INPUT Voltage Range (Vdc)	INPUT Current		OUTPUT Voltage (Vdc)	OUTPUT Current Full load (mA)	EFFICIENCY @FL (% .typ.)	Capacitor Load @LF (µF .max.)
		No-Load (mA .max.)	Full Load (mA .typ.)				
SE-053R3S	5	25	338	3.3	400	78	470
SE-0505S	5	25	494	5	400	81	470
SE-057R2S	5	35	500	7.2	278	80	470
SE-0509S	5	25	482	9	222	83	470
SE-0512S	5	30	476	12	167	84	470
SE-0515S	5	30	471	15	133	85	470
SE-0524S	5	30	465	24	83	86	470
SE-123R3S	12	20	152	3.3	400	72	470
SE-1205S	12	20	206	5	400	81	470
SE-127R2S	12	15	208	7.2	278	80	470
SE-1209S	12	15	196	9	222	85	470
SE-1212S	12	15	196	12	167	85	470
SE-1215S	12	15	196	15	133	85	470
SE-1224S	12	25	196	24	83	85	470
SE-153R3S	15	15	116	3.3	400	76	470
SE-1505S	15	15	165	5	400	81	470
SE-157R2S	15	15	161	7.2	278	83	470
SE-1509S	15	15	167	9	222	80	470
SE-1512S	15	15	158	12	167	84	470
SE-1515S	15	13	155	15	133	86	470
SE-1524S	15	17	159	24	83	84	470
SE-243R3S	24	7	68	3.3	400	81	470
SE-2405S	24	8	100	5	400	83	470
SE-247R2S	24	10	102	7.2	278	82	470
SE-2409S	24	6	98	9	222	85	470
SE-2412S	24	8	97	12	167	86	470
SE-2415S	24	8	97	15	133	86	470
SE-2424S	24	8	95	24	83	88	470
SE-483R3S	48	5	37	3.3	400	74	470
SE-4805S	48	5	53	5	400	79	470
SE-487R2S	48	5	50	7.2	278	83	470
SE-4809S	48	5	50	9	222	83	470

Suffix "H" means 3 KVdc isolation

SE-2W Unregulated Single output

MODEL NUMBER	INPUT Voltage Range (Vdc)	INPUT Current		OUTPUT Voltage (Vdc)	OUTPUT Current Full load (mA)	EFFICIENCY @FL (% .typ.)	Capacitor Load @LF (μ F .max.)
		No-Load (mA .max.)	Full Load (mA .typ.)				
SE-4812S	48	5	51	12	167	81	470
SE-4815S	48	5	51	15	133	82	470
SE-4824S	48	5	48	24	83	86	470

Suffix "H" means 3 KVdc isolation

TEST CONFIGURATIONS

EMI Filter

Input filter components (C1, L, C2, C3) are used to help meet conducted emissions requirement for the module. These components should be mounted as close as possible to the module; and all leads should be minimized to decrease radiated noise.

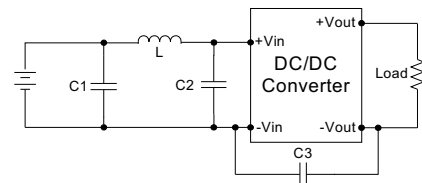

	C1	L	C2	C3
SE-05XXXX	1210, 2.2 μ F/100V	18 μ H		
SE-12XXXX	1210, 2.2 μ F/100V	18 μ H		
SE-15XXXX	1210, 2.2 μ F/100V	18 μ H		
SE-24XXXX	1210, 2.2 μ F/100V	18 μ H	1210, 2.2 μ F/100V	1206, 470pF/2KV
SE-48XXXX	Electrolytic Capacitor, 10 μ F/100V	18 μ H	1210, 2.2 μ F/100V	1206, 470pF/2KV

NOTE

1. Ripple/Noise measured with 20MHz bandwidth.
2. Tested by minimal V_{in} and constant resistive load.
3. Measured Input reflected ripple current with a simulated source inductance of 12 μ H and a source capacitor C_{in} (47 μ F, ESR < 1.0 Ω at 100KHz).
4. Exceeding the absolute ratings of the unit could cause damage. It is not allowed for continuous operating.
5. Operation under no-load conditions will not damage these devices, however they may not meet all listed specifications.
6. Input filter components are required to help meet conducted emission class B, which application refer to the EMI Filter of design & feature configuration.
7. An external filter capacitor is required if the module has to meet IEC61000-4-4 and IEC61000-4-5. The filter capacitor SCHMID-M suggest: Nippon - chemi - con KY series, 470 μ F/100V

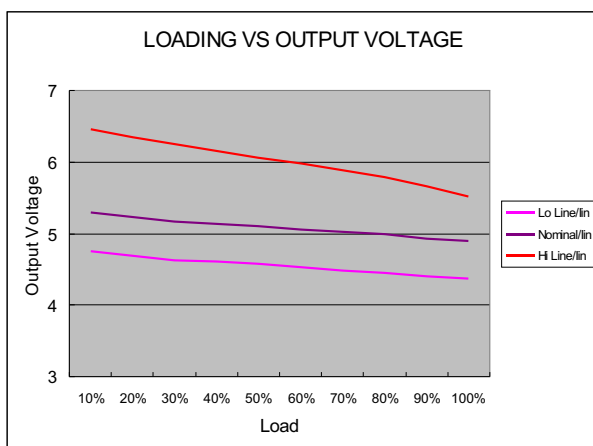

5 Models

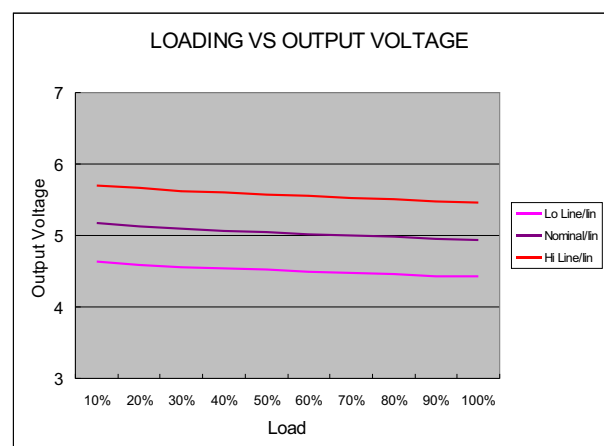

12 Models

SE-2W Unregulated Single output

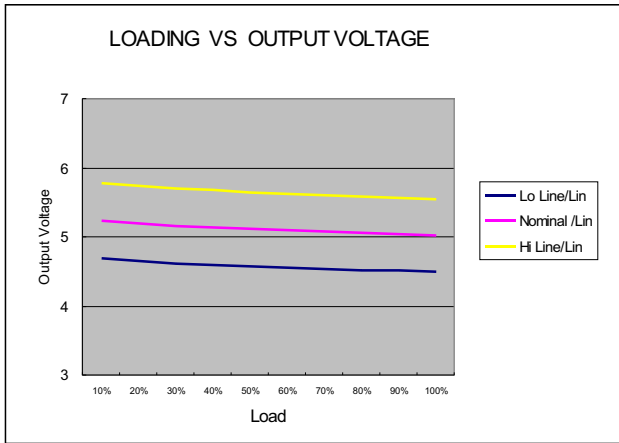

24 Models

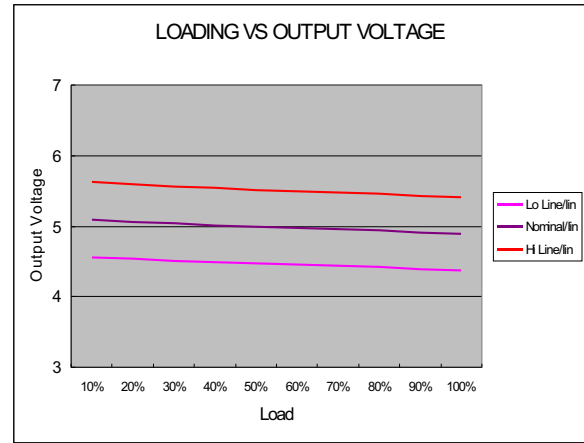

48 Models

MECHANICAL SPECIFICATIONS

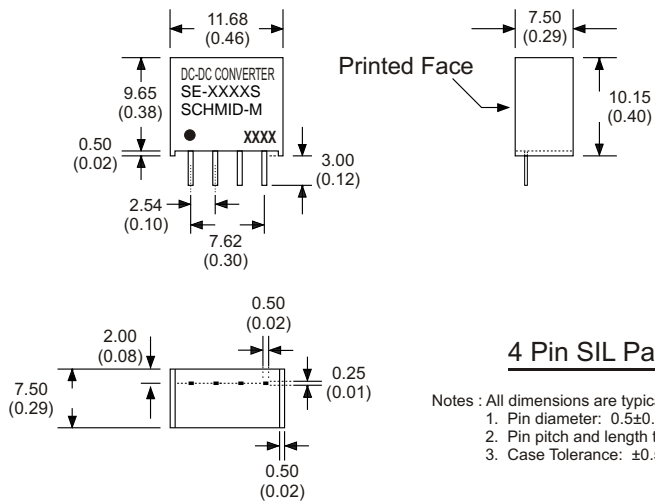

4 Pin SIL Package

- Notes : All dimensions are typical in millimeters (inches).
1. Pin diameter: 0.5 ± 0.05 (0.02 ± 0.002)
 2. Pin pitch and length tolerance: ± 0.35 (± 0.014)
 3. Case Tolerance: ± 0.5 (± 0.02)

PIN CONNECTIONS	
PIN NUMBER	SINGLE
1	-V Input
2	+V Input
3	-V Output
4	+V Output

(The Pin Connection of high isolation one is the same with normal one.)