

SSVR - 1.0 Series



1A Output Current, Non-Isolated DC/DC converter

Features

- SMD-Package, Full SMD Technology
- Non-Isolated Regulator with Very Low Standby Current
- Adjustable Output Voltage
- Continuous Short Circuit Protection
- Remote ON/OFF Control
- Low Ripple and Noise
- Excellent Line / Load Regulation
- Efficiency Up to 96%



The SSVR-1.0 series is a family of cost effective 1.2~15W single output buck DC-DC converters. These converters achieve low cost and small SMD package, output voltage adjustment, remote ON/OFF control, continuous short circuit protection with automatic restart, good line / load regulation and ultra low quiescence current. Input voltages of 3~5.5 and 4.6~36 with output voltage of 1.2, 1.5, 1.8, 2.5, 3.3, 5, 6.5, 9, 12 and 15Vdc. High performance features include high efficiency operation up to 96%.

All specifications typical at Ta=25°C, nominal input voltage and full load unless otherwise specified.

OUTPUT SPECIFICATIONS	
Voltage Accuracy	±2%, max.
Output voltage adjustability (Trim)(1)	±10%, max.
Output Current (Full Load)	1000mA, max.
Line regulation	Output<3.0Vdc:±0.5%, max. Output>3.0Vdc:±0.3%, max.
Load regulation	(From 10% to 100% Load) ±0.6%, max.
Ripple & Noise (2)	Output<7.5Vdc:50mVpk-pk, max. Output>7.5Vdc:75mVpk-pk, max.
Short Circuit Protection	Continuous (Automatic Recovery)
Temperature coefficient	±0.02%/°C
Capacitor Load(3)	330 μF, max.
Transient Recovery Time(4)	250μs, typ.
Transient Response Deviation(4)	Output<4Vdc : ±5%, max. Output>4Vdc : ±3%, max.

INPUT SPECIFICATIONS	
Input Voltage Range	See table
Start up Time (Nominal Vin and constant resistive load)	5mS, typ.
Input Current (No-Load)	See table, typ.
Input Current (Full-Load)	See table, typ.
Input Filter	Capacitors
Input Reflected Ripple Current(5)	35mApk-pk, typ.
Remote ON/OFF (CTRL)(6)	
ON:	2~5Vdc or open circuit
OFF:	0~0.4Vdc or short circuit pin10 and -Vin
OFF Idle current:	05 series:0.3mA, max. 24 series:0.8mA, max.

ABSOLUTE MAXIMUM RATINGS(7)	
These are stress ratings. Exposure of devices to any of these conditions may adversely affect long-term reliability.	
Input Surge Voltage (100mS)	05 series:6Vdc, max. 24 series:40Vdc, max.

NOTE

1. The 1.2Vdc output model only support Vadj up, do not support Vadj down.
2. Ripple/Noise measured with 20MHz bandwidth.
3. Tested by minimal Vin and constant resistive load.
4. Tested by normal Vin and 50% load step change (50%-100% of Io).
5. Input reflected ripple current is measured through a source inductor L1(12μH) and a source capacitor C1=10μF at nominal input and full load.
6. The remote on/off control pin is referenced to -Vin.
7. Do not operate the unit(s) exceeding the absolute maximum rating, over rating causes damage to the units.
8. "Nature Convection" is usually about 30-65 LFM but is not equal to still air (0 LFM).
9. The SSVR-1.0 series can meet EN55032 Class B with an external filter in parallel with the inout pins.
10. An external filter capacitor is required if the module has to meet IEC61000-4-4 and IEC61000-4-5.

GENERAL SPECIFICATIONS	
Efficiency	See table, typ.
Switching Frequency	05 series:1.2MHz, typ. 24 series:410KHz, typ.
Humidity	95% rel H
Reliability Calculated MTBF(MIL-HDBK-217 F)	05 series:>35Mhrs 24 series:>4.7Mhrs
Safety Standard (design to meet)	UL/cUL 60950-1 , 62368-1 IEC/EN 60950-1 , 62368-1

ENVIRONMENT SPECIFICATIONS	
Operating Temperature	-40°C~ +105°C(See Derating Curve) -40°C ~ +65°C(For 100% Load)
Storage Temperature	-55°C ~ +125°C
Over Temperature Protection (Internal IC junction)	+150°C, typ.
Cooling(8)	Nature Convection
Lead-free Reflow Solder Process	IPC/JEDEC J-STD-020D.1
Reflow Temperature	Peak 245°C(10 sec),max.
Moisture Sensitivity Level (MSL)	IPC/JEDEC J-STD-020D.1 Level 1
Vibration	MIL-STD-810F

PHYSICAL SPECIFICATIONS	
Weight	1.4g
Dimensions	0.60"x0.47"x0.15"

EMC CHARACTERISTICS		
Radiated Emissions(9)	EN55032	CLASS B
Conducted Emissions(9)	EN55032	CLASS B
ESD	IEC61000-4-2	Perf. Criteria A
RS	IEC61000-4-3	Perf. Criteria A
EFT(10)	IEC61000-4-4	Perf. Criteria A
Surge(10)	IEC61000-4-5	Perf. Criteria A
CS	IEC61000-4-6	Perf. Criteria A
PFMF	IEC61000-4-8	Perf. Criteria A

PART NUMBER STRUCTURE

SSVR 1 - 24 05 R

Series Name
 Output Current
 1.0 - 1A
 Input Voltage Range
 05 - 3~5.5V
 24 - 4.6~36V
 Output Voltage
 1R2 - 1.2V
 1R5 - 1.5V
 1R8 - 1.8V
 2R5 - 2.5V
 3R3 - 3.3V
 05 - 5V
 6R5 - 6.5V
 09 - 9V
 12 - 12V
 15 - 15V
 Packing Options
 "blank" - standard Tube packing
 R - for tape & reel packing

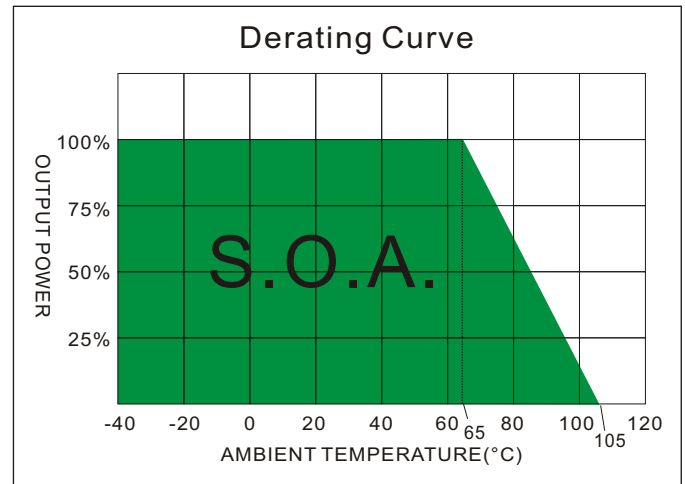

MODEL SELECTION GUIDE

MODEL NUMBER	INPUT Voltage Range (Vdc)	INPUT Current (mA)			OUTPUT		EFFICIENCY		Capacitor Load (µF)
		No-Load	Full-Load Vin (Min)	Full-Load Vin (Max)	Voltage (Vdc)	Current (mA)	Vin (Min) @FL (%)	Vin (Max) @FL (%)	
SSVR1-051R2	5 (3-5.5)	0.4	442	242	1.2	1000	90.5	90.5	330
SSVR1-051R5	5 (3-5.5)	0.4	544	297	1.5	1000	92	92	330
SSVR1-051R8	5 (3-5.5)	0.4	649	354	1.8	1000	92.5	92.5	330
SSVR1-052R5	5 (3.8-5.5)	0.4	697	484	2.5	1000	94.5	94	330
SSVR1-241R2	24 (4.6-36)	1.5	300	47	1.2	1000	87	72	330
SSVR1-241R5	24 (4.6-36)	1.5	367	55	1.5	1000	89	76	330
SSVR1-241R8	24 (4.6-36)	1.5	433	64	1.8	1000	90.5	79	330
SSVR1-242R5	24 (4.6-36)	1.5	588	84	2.5	1000	92.5	83	330
SSVR1-243R3	24 (4.75-36)	1.5	740	106	3.3	1000	94	86.5	330
SSVR1-2405	24 (6.5-36)	1.5	806	156	5	1000	95.5	89.5	330
SSVR1-246R5	24 (9-36)	1.5	765	201	6.5	1000	94.5	90	330
SSVR1-2409	24 (12-36)	1.5	786	272	9	1000	95.5	92	330
SSVR1-2412	24 (15-36)	1.5	843	359	12	1000	95	93	330
SSVR1-2415	24 (18-36)	1.5	869	444	15	1000	96	94	330

TEST CONFIGURATIONS

Input Reflected Ripple Current Test Step

Input reflected ripple current is measured through a source inductor L_{in} (12µH) and a source capacitor C_{in} (10µF, ESR<1.0Ω at 100kHz) at nominal input and full load.

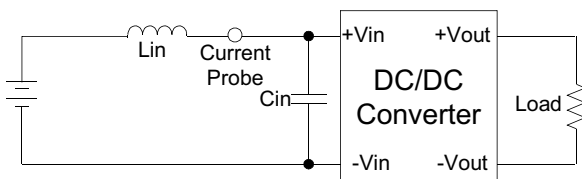

Output Ripple & Noise Measurement Test

Use a 10µF electrolytic capacitor and 0.1µF ceramic capacitor. The Scope measurement bandwidth is 0-20MHz.

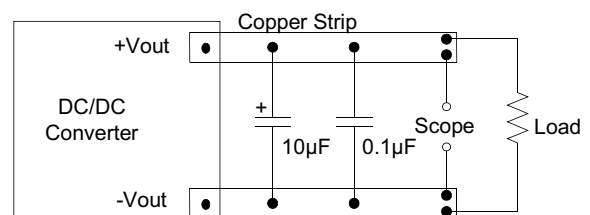

DESIGN CONFIGURATIONS

Standard Application Circuit

1. Cin is required and must be connected close to the pin terminal of the module. (Cin=10µF)
2. Cout=47µF(Optional)

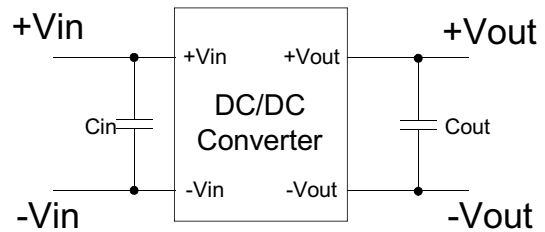

Remote ON / OFF Test Step

Input voltage(2~5Vdc) connect to Pin10 or open, converter ON.
 Input voltage(0~0.4Vdc) connect to Pin10 or short, converter OFF.

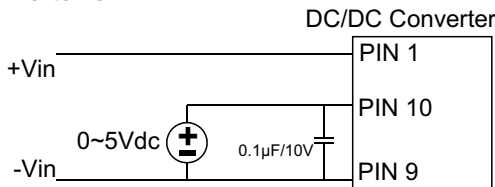

Output Voltage Adjustment

Pin 6 via a resistor to Pin 5(+Vout), Vo trim down.
 Pin 6 via a resistor to Pin 7(-Vout),Vo trim up.

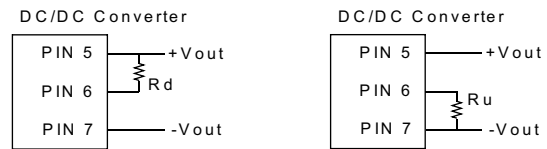

Trim down

Trim up

EMC COUNTERMEASURES

EMI Countermeasures

Input filter components (Cin, C1, L1) are used to help meet EMI requirement for the module.
 These components should be mounted as close as possible to the module; and all leads should be minimized to decrease radiated noise.

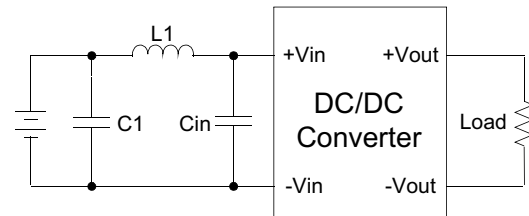

	C1	L1	Cin
SSVR1-05XX	1206,10µF,50V	6.8µH	1206, 10µF,50V
SSVR1-24XX	1206,4.7µF,50V	33µH	1206, 10µF,50V

EFT & Surge Test Countermeasures

The filter SCHMID-M suggest: 05V in models : Nippon - chemi - con KY series , 2200uF/50V and a TVS , 3KW , 6.0V
 24V in models : Nippon - chemi - con KY series , 330uF/100V and a TVS , 3KW , 36V

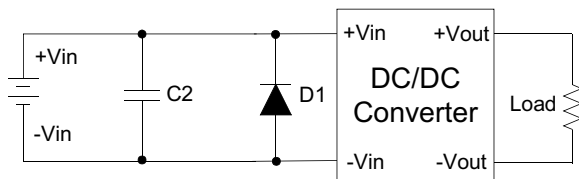

	C2	D1
SSVR1-05XX	2200uF,50V	SMDJ 6.0A
SSVR1-24XX	330uF,100V	SMDJ 36A

MECHANICAL SPECIFICATIONS

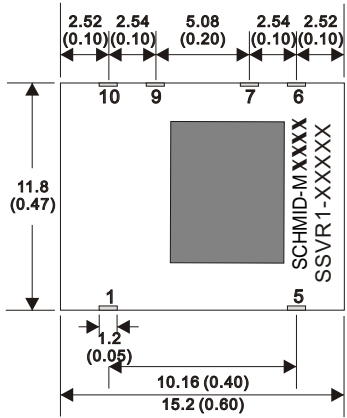

Top view

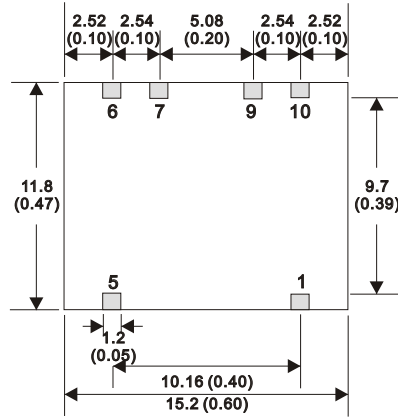

Bottom view

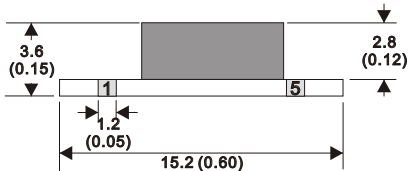

Side view

SMD 10Pin Package

- Notes : All dimensions are typical in millimeters (inches).
1. Pin pitch tolerances: ± 0.25 (± 0.01)
 2. Pin profile tolerance: ± 0.1 (± 0.004)
 3. Other tolerances: ± 0.5 (± 0.02)

PIN CONNECTIONS	
PIN NUMBER	SINGLE
1	+V Input
5	+V Output
6	Trim
7	-V Output
9	-V Input
10	Remote ON/OFF

Tube dimension

Standard packing - Tube

■ 1 Tube contains 40 converters

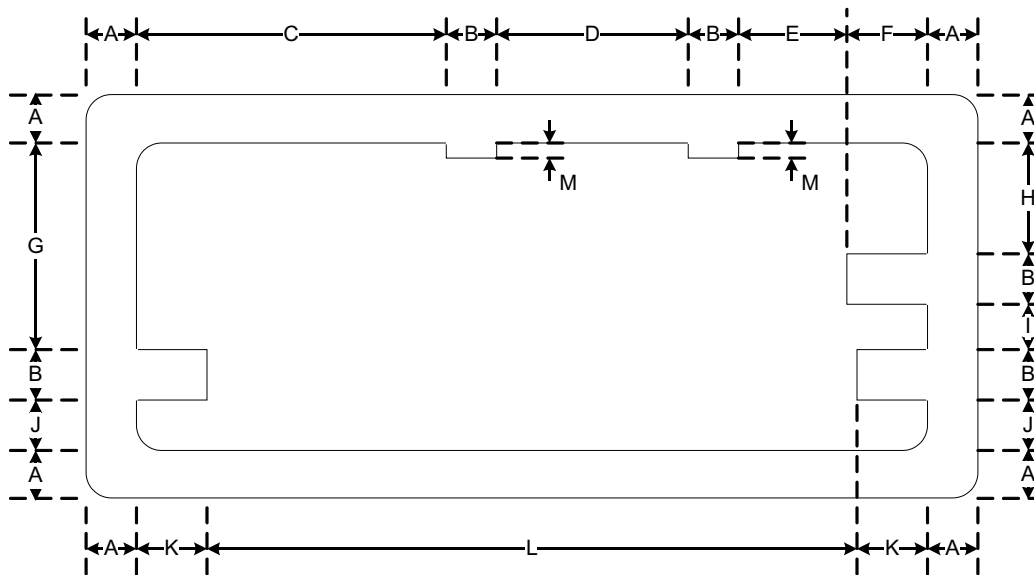
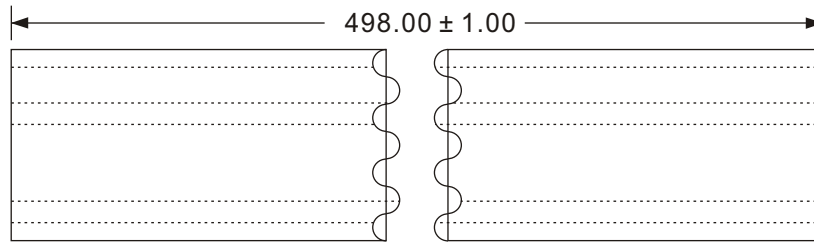

dimensions in [mm]

Tube Length : 498 ± 1.0 mm														
ITEM	A		B		C		D		E		F		G	
DIM	1.0	+0.2 -0.2	1.0	+0.2 -0.2	5.9	+0.2 -0.2	3.8	+0.2 -0.2	2.4	+0.2 -0.2	1.6	+0.10 -0.2	4.15	+0.2 -0.1
ITEM	H		I		J		K		L		M			
DIM	2.15	+0.2 -0.1	1.0	+0.2 -0.1	1.0	+0.2 -0.2	1.4	+0.2 -0.2	12.9	+0.2 -0.2	0.3	+0.1 -0.1		

Tape & Reel dimension

Optional packing - Tape & Reel

- Specifications shall conform with current EIA-481 standard
- 1 Reel contains 500 converters
- Use appendix <<-R>> on order code

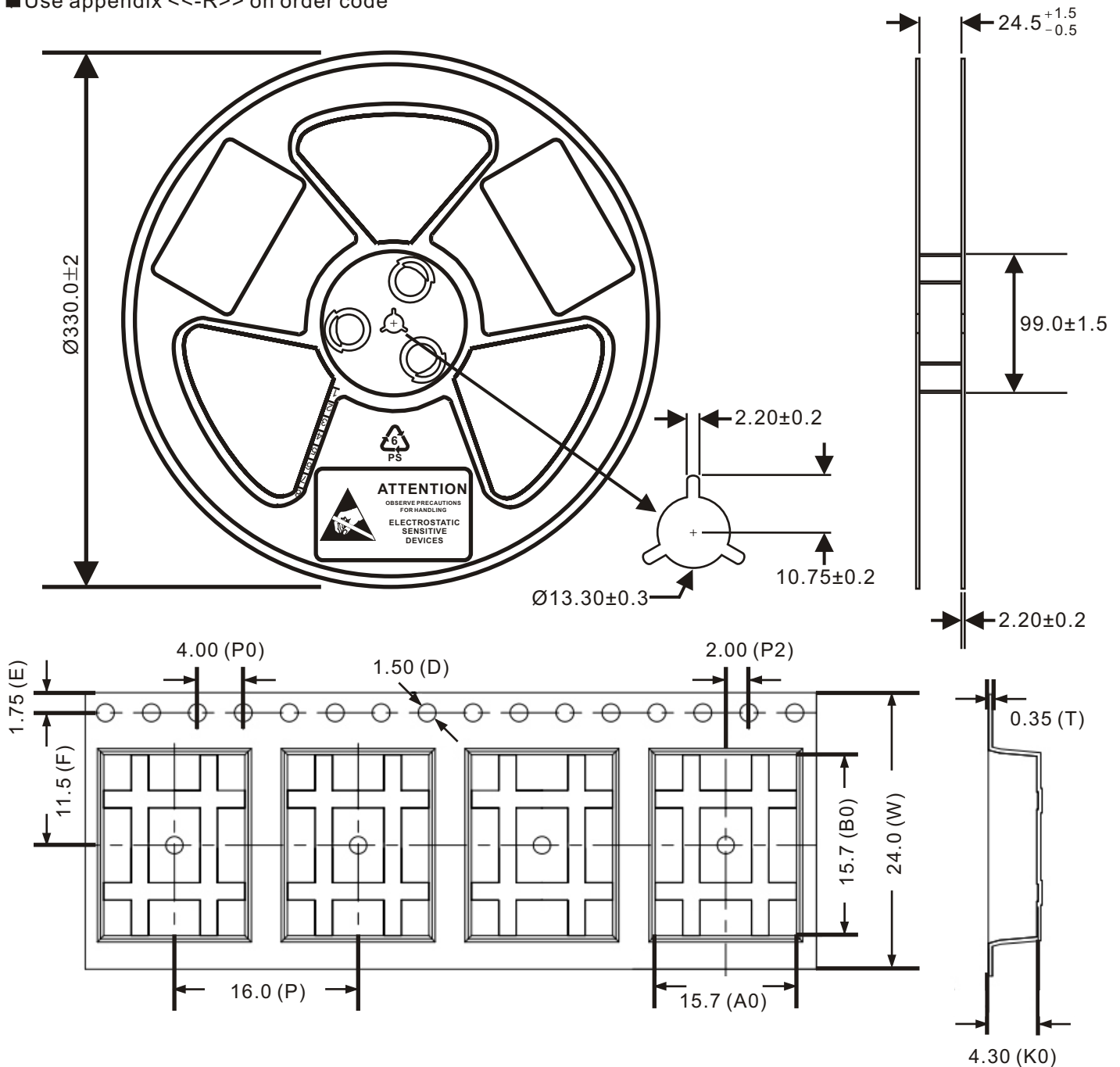

dimensions in [mm]

NOTE:

1. Material: Black Polystyrene.
2. Camber not to exceed 1mm in 100mm.
3. 10 sprocket hole pitch cumulative tolerance ± 0.2
4. A0 and B0 measured on a plane 0.3mm above the bottom of the pocket.
5. K0 measured from a plane on the inside bottom of the pocket to the top surface of the carrier.
6. Pocket position relative to sprocket hole measured as true position of pocket, not pocket hole.

Carrier Length: 30M / 22" reel, Q'ty= 500 pcs/13" reel																						
ITEM	W		A0		B0		K0		T	P		E		D		P0		P2				
DIM	24.0	+0.30 -0.30	12.3	+0.20 -0.10	15.7	+0.20 -0.10	4.30	+0.20 -0.10	0.35	+0.05 -0.05	16.0	+0.10 -0.10	11.5	+0.15 -0.15	1.75	+0.10 -0.10	1.50	+0.10 -0.00	4.00	+0.10 -0.10	2.00	+0.10 -0.10