

30W, AC-DC converter



FEATURES

- Universal 85-264VAC or 100-370VDC input voltage
- 3×2 inch high power density
- Operating ambient temperature range: -25°C to +70°C
- Output short circuit, over-current, over-voltage protection
- High efficiency, high reliability
- Regulated output, low output ripple & noise
- EMI performance meets CISPR32 / EN55032 CLASS B
- 2 years warranty
- Safety according to UL/IEC62368, UL/EN60335

SLO30-10A/Dxx series is one of SCHMID-M's compact size power converter. It features universal AC input and at the same time accepts DC input voltage, low power consumption, high efficiency, high reliability, reinforced isolation. It offers good EMC performance compliant to IEC/EN61000-4, CISPR32/EN55032, UL/EN60335 and meets UL/EN/IEC62368 standards. The converters are widely used in industrial, office and civil applications. For extremely harsh EMC environment, we recommend using the application circuit show in Design Reference of this datasheet.

Selection Guide

Certification	Part No.	Output Power	Nominal Output Voltage and Current		Efficiency at 230VAC (%) Typ.	Capacitive Load (µF) Max.	
			(Vo1/Io1)	(Vo2/Io2)		Vo1	Vo2
EN/UKCA	SLO30-10D0505-30	30W	5V/3000mA	5V/3000mA	79	10000	10000
	SLO30-10D0512-15		5V/2520mA	12V/1440mA	81	10000	5200
	SLO30-10D0524-10		5V/1440mA	24V/960mA	84	12000	800
	SLO30-10A12		+12V/1250mA	-12V/1250mA	82	5200	5200
	SLO30-10A15		+15V/1000mA	-15V/1000mA	82	4500	4500

Input Specifications

Item	Operating Conditions	Min.	Typ.	Max.	Unit
Input Voltage Range	AC input	85	--	264	VAC
	DC input	100	--	370	VDC
Input Frequency		47	--	63	Hz
Input Current	115VAC	--	--	750	mA
	230VAC	--	--	450	
Inrush Current	115VAC	--	20	--	A
	230VAC	--	30	--	
Leakage Current	240VAC/50Hz	0.25mA Max.			
Hot Plug		Unavailable			

Output Specifications

Item	Operating Conditions	Min.	Typ.	Max.	Unit	
Output Voltage Accuracy	Vo1	--	±2	--		
	Vo2 (A model)	--	±4	--		
	Vo2 (D model)	--	±6	--		
Line Regulation	Vo1	SLO30-10D0505-30	--	±1	%	
		Others	--	±0.5		
	Vo2	SLO30-10D0505-30	--	±1		
		Others	--	±1		
Load Regulation	Balanced load	A model	--	±2	--	
		D mode	Vo1	--	±1	--
			Vo2	--	±2	--

AC/DC Converter

SLO30-10A/Dxx Series

Ripple & Noise*	20MHz bandwidth (peak-to-peak value), room temperature	Vo1	--	--	50	mV
		Vo2	--	--	200	
Stand-by Power Consumption	230VAC		--	--	0.5	W
Temperature Coefficient	Vo1		--	±0.02	--	%/°C
Short Circuit Protection		Hiccup or turn off, continuous, self-recovery				
Over-current Protection		≥110%Io, self-recovery				
Over-voltage Protection	5VDC output		≤7.5V	Output voltage hiccup clamp or turn off		
	12/15VDC output		≤20V			
Minimum Load			10	--	--	%
Hold-up Time	115VAC input		--	10	--	ms
	230VAC input		--	50	--	

Note: *The "Tip and barrel method" is used for ripple and noise test, with a 0.1uf ceramic capacitor & 47uf parallel capacitor, please refer to AC-DC Converter Application Notes for specific information.

General Specifications

Item	Operating Conditions	Min.	Typ.	Max.	Unit	
Isolation	Input - output	3000	--	--	VAC	
	Vo1-Vo2 (D model)	500	--	--	VDC	
Operating Temperature		-25	--	+70	°C	
Storage Temperature		-25	--	+85		
Storage Humidity		--	--	90	%RH	
Altitude		--	--	2000	m	
Power Derating	-25°C to -10°C	1.0	--	--	% / °C	
	+50°C to +70°C	SLO30-10D0512-15 SLO30-10D0524-10 SLO30-10A15	3.0	--		--
		SLO30-10D0505-30 SLO30-10A12	3.5	--		--
	85VAC-140VAC	0.55	--	--	%/VAC	
Safety Standard		EN62368-1, BS EN 62368-1 (Report); Design refer to UL/IEC62368-1, UL/EN60335-1				
Safety Class		CLASS II				
MTBF		MIL-HDBK-217F@25°C >300,000 h				

Mechanical Specifications

Dimension	76.20 x 50.80 x 28.00 mm
Weight	65g (Typ.)
Cooling method	Free air convection

Electromagnetic Compatibility (EMC)

Emissions	CE	CISPR32/EN55032	CLASS B
	RE	CISPR32/EN55032	CLASS B
Immunity	ESD	IEC/EN61000-4-2	Contact ±6KV Perf. Criteria B
	RS	IEC/EN61000-4-3	10V/m Perf. Criteria A
	EFT	IEC/EN61000-4-4	±2KV Perf. Criteria B
	Surge	IEC/EN61000-4-5	line to line ±1KV Perf. Criteria B
	CS	IEC/EN61000-4-6	10Vr.m.s Perf. Criteria A
	Voltage dips, short interruption and voltage variations	IEC/EN61000-4-11	100% dip 1 periods, 30% dip 25 periods, 100% interruptions 250 periods Perf. Criteria B

AC/DC Converter

SLO30-10A/Dxx Series

Product Characteristic Curve

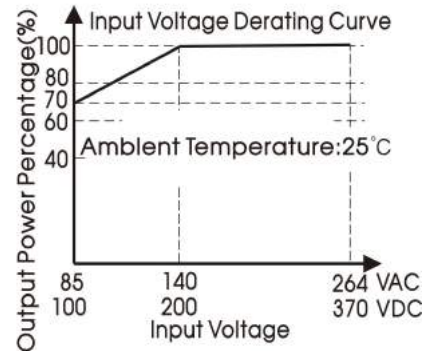
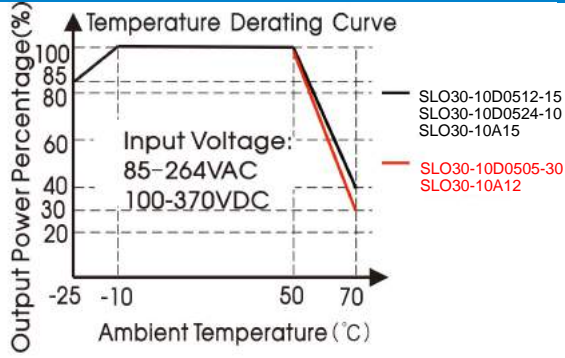

Note: ① With an AC input between 85-140VAC and a DC input between 100-200VDC, the output power must be derated as per temperature derating curves;
 ② This product is suitable for applications using natural air cooling; for applications in closed environment please consult factory or one of our FAE.

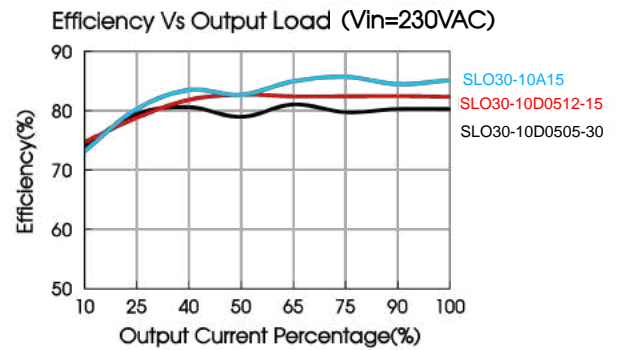
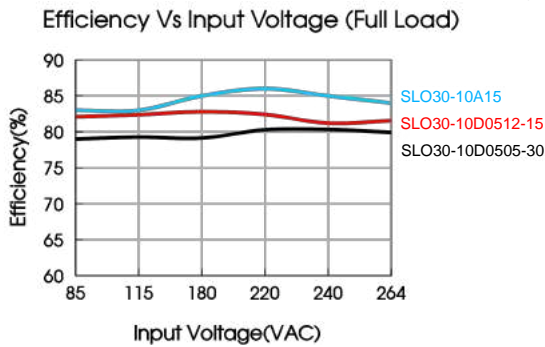

Design Reference

1. Typical application

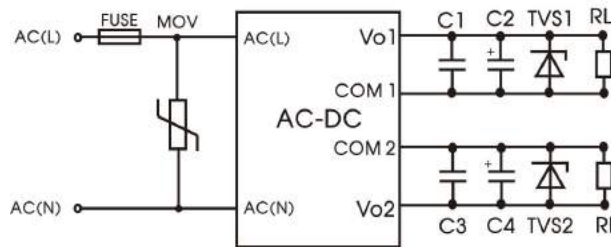

Fig. 1: Typical circuit diagram (SLO30-10Axx Series)

Part No.	FUSE	MOV	C1, C3 (μF)	C2, C4 (μF)	TVS1, TVS2
SLO30-10A12	2A/250V slow-blow	S14K300	0.1	47	SMBJ20A
SLO30-10A15					SMBJ20A

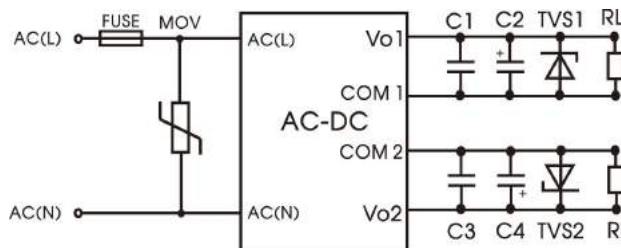

Fig. 2: Typical circuit diagram (SLO30-10Dxx Series)

Part No.	FUSE	MOV	C1, C3 (μF)	C2, C4 (μF)	TVS1	TVS2
SLO30-10D0505-30	2A/250V slow-blow	S14K300	0.1	47	SMBJ7.0A	SMBJ7.0A
SLO30-10D0512-15					SMBJ7.0A	SMBJ20A
SLO30-10D0524-10					SMBJ7.0A	SMBJ30A

Output Filter Components:

We recommend using an electrolytic capacitor with high frequency, and low ESR rating for C2, C4 (refer to manufacture's datasheet). C1, C3 are ceramic capacitors used for filtering high-frequency noise. Choose a capacitor voltage rating with at least 20% margin, in other words not exceeding 80%. And TVS is a recommended suppressor diode to protect the application in case of a converter failure.

AC/DC Converter

SLO30-10A/Dxx Series

Dimensions and Recommended Layout

THIRD ANGLE PROJECTION 

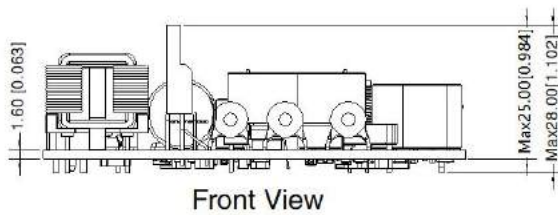
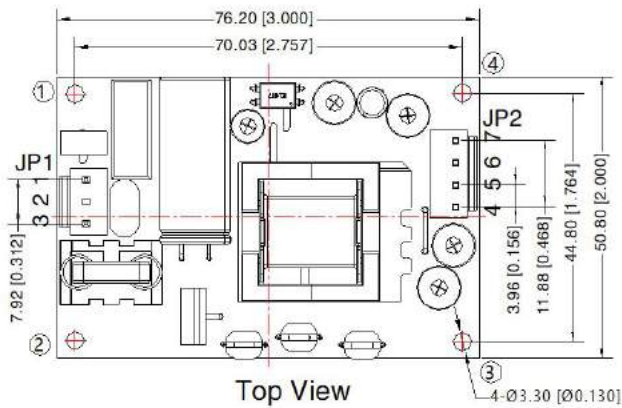

Note:
 Unit: mm[inch]
 General tolerances: ± 0.50 [± 0.020]
 Type A: COM1 is electrically connected to COM2
 The layout of the device is for reference only, please refer to the actual product

Pin-Out			
Connectors	Pin	Mark	Client Connectors
JP1	1	AC(L)	Housing: JST VHR Contact: JSTSVH-21T-P1.1 or equivalent
	2	NoPin	
	3	AC(N)	
JP2	4	Vo2	Housing: JST VHR Contact: JSTSVH-21T-P1.1 or equivalent
	5	COM2	
	6	COM1	
	7	Vo1	

Position	Screw Spec.	L(Recommend)	Torque(max)
①-④	M3	6mm	0.4N · m

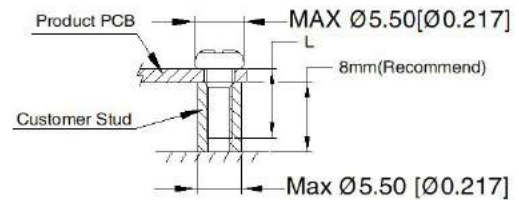

Note:

1. Unless otherwise specified, parameters in this datasheet were measured under the conditions of $T_a=25^\circ\text{C}$, humidity<75% with nominal input voltage and rated output load;
2. All index testing methods in this datasheet are based on our company corporate standards;
3. We can provide product customization service, please contact our technicians directly for specific information;
4. Products are related to laws and regulations: see "Features" and "EMC";
5. Our products shall be classified according to ISO14001 and related environmental laws and regulations, and shall be handled by qualified units.